

Category 3, EN 954-1 PNOZ V



Emergency stop relay and safety gate monitor in accordance with VDE 0113-1, 11/98, EN 60204-1, 12/97 and IEC 204-1, 11/98.

Features

- Single-channel or dual-channel without the detection of shorts across the input contacts
- Supply voltage: 24 VDC
- 1 delay-off safety contact

Approvals

	PNOZ V
	●
	●
	●

Description

- 90 mm P-75 housing, DIN Rail mounting
- Positive-guided relay outputs, instantaneous:
 - 3 safety contacts (N/O)
 - 1 auxiliary contact (N/C)
- Positive-guided relay outputs, delay-off:
 - 1 safety contact (N/O)
- Delay-off time can be selected: 12 time periods on units with variable ranges

Technical Data	PNOZ V
Electrical Data	
Supply Voltage	24 VDC
Tolerance	85 ... 110 %
Power Consumption	Approx. 5 W
Voltage and Current at the Input and, Reset Circuits and Feedback Control Loop	24 VDC, 50 mA
Switching Capability	
Contacts 13-14, 23-24, 33-34, 41-42 in accordance with EN 60947-4-1, 10/91	AC1: 240 V/8 A/2000 VA 400 V/ 5 A/2000 VA DC1: 24 V/8 A/200 W
in accordance with EN 60947-5-1, 10/91 (DC13: 6 cycles/min.)	AC15: 230 V/5 A; DC13: 24 V/4 A
Contact 57-58 in accordance with EN 60947-4-1, 10/91	AC1: 240 V/4 A/1000 VA DC1: 24 V/4 A/100 W
in accordance with EN 60947-5-1, 10/91 (DC13: 6 cycles/min.)	AC15: 230 V/4 A; DC13: 24 V/4 A
Output Contacts	3 safety contacts (N/O) 1 auxiliary contact (N/C)
Output Contacts with Delay-on De-energisation	1 safety contact (N/O)
Contact Fuse Protection (EN 60947-5-1, 10/91)	
instantaneous contact	10 A quick or 6 A slow
delayed contact	6 A quick or 4 A slow
Times	
Delay-on Energisation	Approx. 150 ms
Delay-on De-energisation	Approx. 50 ms
Delay-on De-energisation, delayed contact 57/58	Selectable time ranges: Approx. 0.1 ... 3 s; 0.5 ... 30 s; 0.5 ... 300 s; Fixed time ranges: 3 s; 10 s
Recovery Time	Approx. 0.3 s
Simultaneity channel 1/2	Approx. 75 ms
Max. Supply Interruption before De-energisation	Approx. 35 ms
Mechanical Data	
Torque Setting on Connection Terminals	1.2 Nm (screws)
Maximum Cross Section of External Conductors	2 x 2.5 mm ² Single-core or multi-core with crimp connectors
Dimensions (H x W x D)	75 x 90 x 110 mm
Weight	480 g

- Connections for
 - E-STOP button
 - safety gate limit switch
 - reset button
- LEDs for channel 1/2 and supply voltage
- Increase in the number of safety contacts available by connecting expander modules.

Operating Modes

- Single-channel operation
- Dual-channel operation
- Automatic reset
- Manual reset

Category 3, EN 954-1 PNOZ V

Internal Wiring Diagram

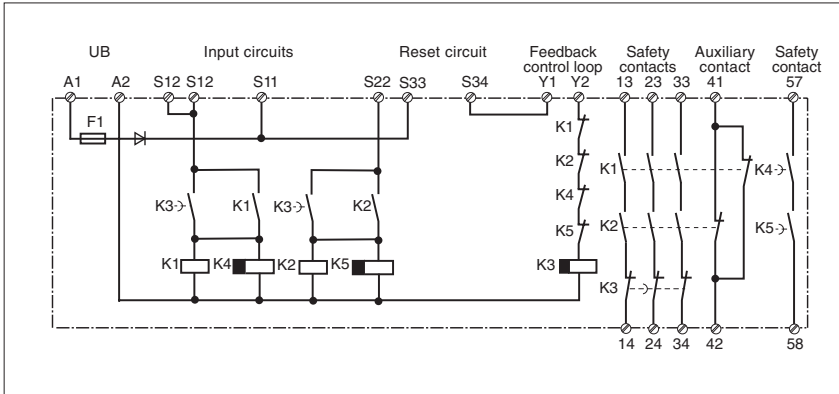

- Increase in safety contacts
The number of output contacts can be increased by using expander modules or relays/contactors with positive-guided contacts.

External Wiring

- Example 1
Single-channel E-STOP wiring with manual reset.

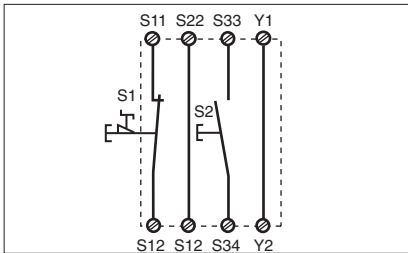

- Example 4
Dual-channel safety gate control with manual reset.

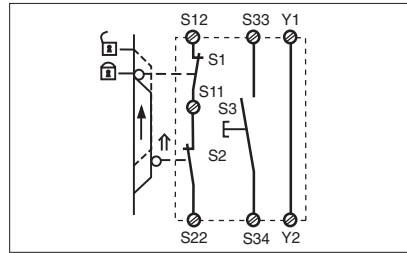

- Example 2
Dual-channel E-STOP wiring with manual reset.

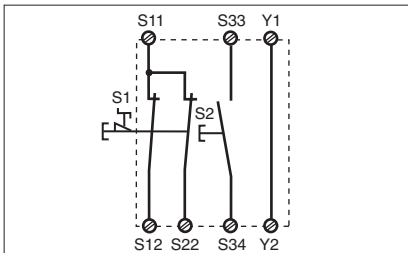

- Example 5
Dual-channel safety gate control with automatic reset.

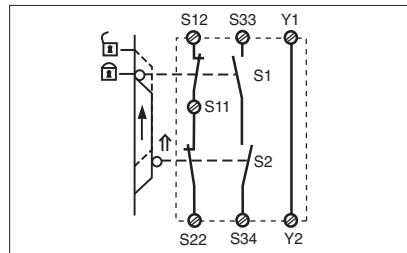

- Example 3
Single-channel safety gate control with manual reset.

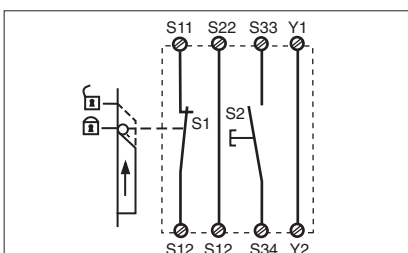

– Key

- S1/2: E-STOP or safety gate switch
- S3: Reset button
- ↑ Switch operated
- ⬆ Gate open
- ⬆ Gate closed

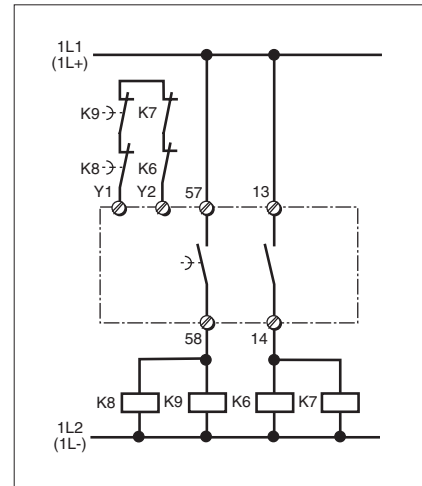

Category 3, EN 954-1 PNOZ V

General Technical Data

Unless stated otherwise in the technical details for the specific unit

Electrical Data

Frequency Range AC	50 ... 60 Hz
Residual Ripple DC	160 %
Contact Material	AgSnO ₂
Continuous Duty	100 %

Environmental Data

EMC	EN 50081-1, 01/92, EN 50082-2, 03/95
Vibration in accordance with EN 60068-2-6, 04/95	Frequency: 10 ... 55 Hz, Amplitude: 0.35 mm
Climatic Suitability	DIN IEC 60068-2-3, 12/86
Airgap Creepage	DIN VDE 0110 part 1, 04/97
Ambient Temperature	-10 ... +55 °C
Storage Temperature	-40 ... +85 °C

Mechanical Data

Torque Setting on Connection Terminals	0.6 Nm (screws)
Mounting Position	Any
Housing Material	Thermoplast Noryl SE 100
Protection	Mounting: IP 54 Housing: IP 40 Terminal Range: IP 20

The units were tested in accordance with the relevant standards current at the time of development.

Order References

Type	t	U _B	Order No.
PNOZ V	3 s	24 V DC	474 789
PNOZ V	30 s	24 V DC	474 790
PNOZ V	3 s fest	24 V DC	474 796
PNOZ V	10 s fest	24 V DC	474 799
PNOZ V	300 s	24 V DC	474 791